

004-506

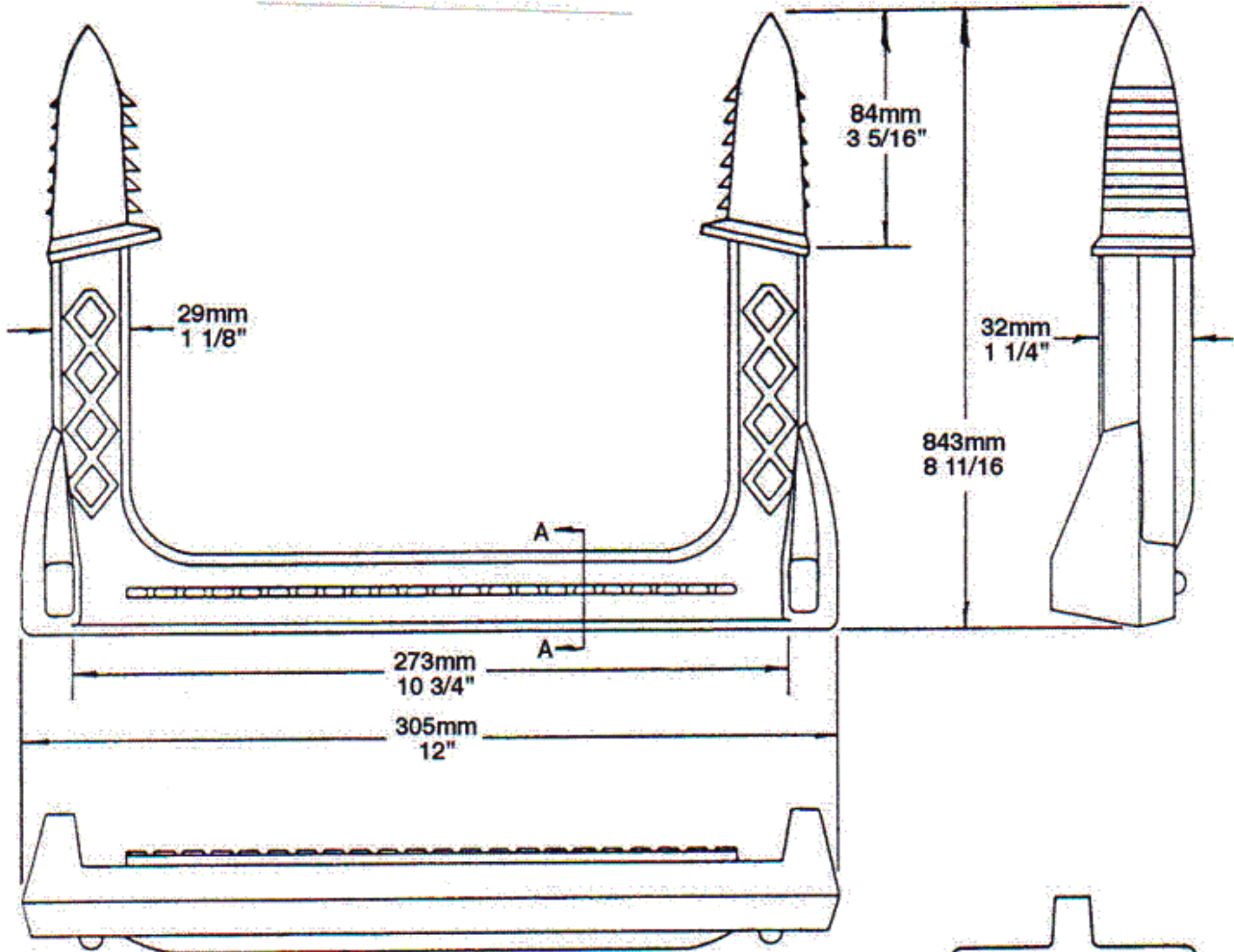

Copolymer Polypropylene Plastic

13mm 1/2" GRADE 60 STEEL REINFORCEMENT

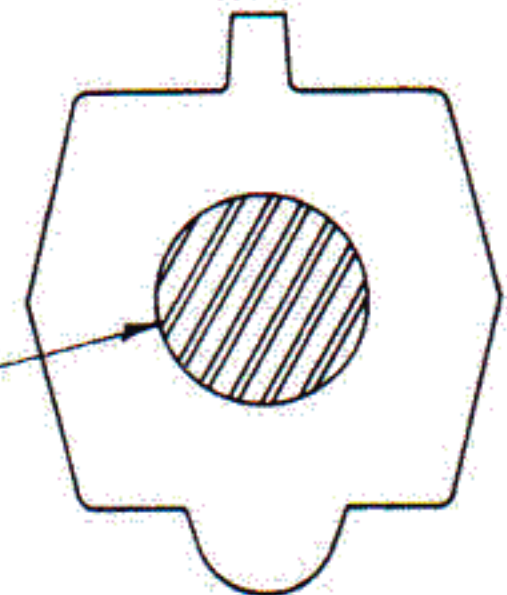

SECTION-A

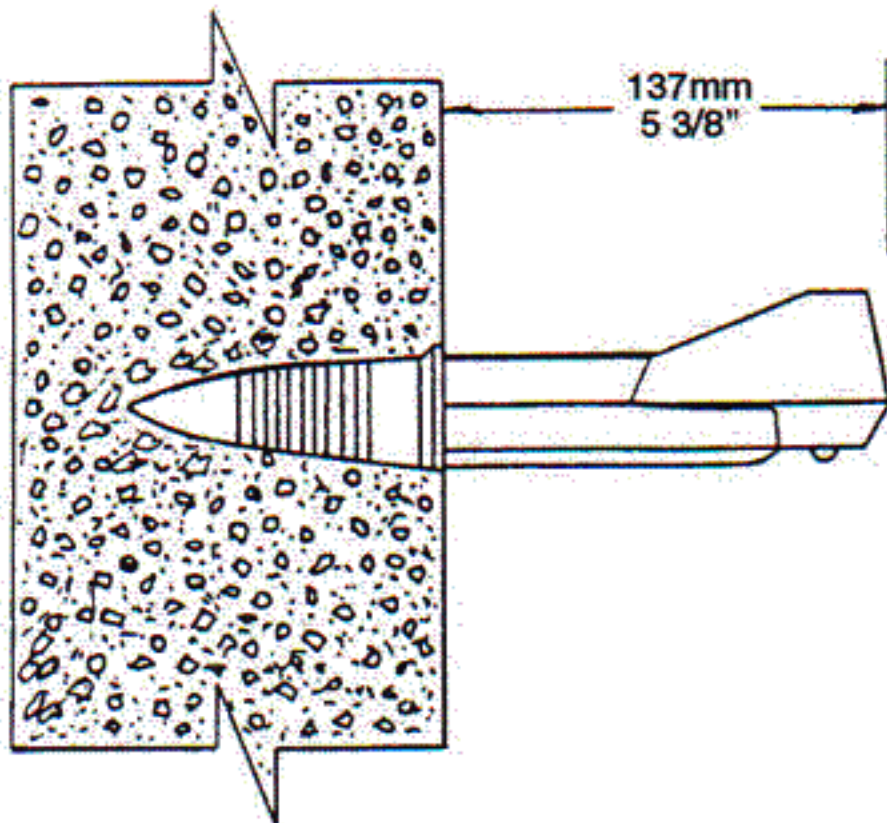

MEETS: ASTM-C-478
ASTM-D-4101
ASTM-A-615
AASHTO-M-199



M.A. INDUSTRIES, INC.